

Limited 2 Year Warranty

Fuji Industrial Spray Equipment Ltd. issues a 24 month limited warranty to the purchaser effective from the date of purchase against defects in materials or workmanship. This warranty does not cover abuse, accidental damage, misuse, normal wear parts, motor brush replacement, or spray gun maintenance and clean-up. Warranty is void if repairs are made or attempted by unauthorized persons. At our option, Fuji Spray will repair or replace defective parts without charge provided the purchaser return parts prepaid to the nearest authorized service center or to the factory.

Factory returns must first receive a Return Material Authorization. In North America, please call 800-650-0930 to obtain an authorization number. In other countries, please call the company where you purchased the product.

This unit is designed to be used for spray painting and similar operations only. Fuji will not be held liable if equipment is not used solely for the purpose it was designed. Warranty will become void through improper installation or operation. Any modifications to the equipment or deviations from recommended procedures, accidental damage or any related action that impairs or abuses normal wear and care of Fuji spray equipment will also void warranty and liability.

CONTENTS

Contents	1
Safety Precautions	2
Air Control Valve & Diaphragm	3
Spray pattern	4
Fan size	5
Spraying techniques	6
Aircap selection	7
Latex & Viscosity	8 - 9
Viscosity guide	9
Cleaning	9 -10
Pressure pot use	10
Finish Problems	11
Spray Gun Problems	12 -13
Needle Packing & Seals.	14
Parts disassembly	15
Turbine problems	15
Parts diagrams.	16 -18
Gravity Spray Gun.	18
Service information.	19
Warranty information	20
CE Declaration	Back Cover

Please read these instructions carefully before using the equipment

ELECTRICAL

The turbine is powered by a 3-stage or 4-stage (depending on the model) single speed, bypass, air turbine. **This turbine must be connected to the correct voltage.** Please check the label on the base for voltage rating.

ELECTRICAL CONNECTION

For your safety and protection, we have equipped your Fuji turbine with a three-pronged grounding plug on the service cord. This must be plugged into a properly grounded 3-pronged receptacle. (For some countries this may be a 2-pin grounded plug).

SAFETY WARNINGS:

THE TURBINE MUST NOT BE USED IN AN AREA CONTAMINATED BY VOLATILE OR FLAMMABLE MATERIALS SINCE SPARKING CAN BE EXPECTED IN THE NORMAL OPERATION OF THE MOTOR. THIS COULD IGNITE THE CONTAMINANTS CAUSING A DANGEROUS EXPLOSION. KEEP THE TURBINE AT LEAST 18 FEET (5.5 METERS) AWAY FROM THE SPRAYING AREA. FOR HEALTH REASONS, ALWAYS WEAR A RESPIRATOR. PLEASE CHECK WITH THE LOCAL JURISDICTION.

THE SPRAYGUN MUST NEVER BE POINTED AT SOMEONE'S FACE.

THE OPERATOR MUST WEAR SHOES AND THE FLOOR MUST NOT BE WET.

FILTER(S)

The Q-PRO Series turbines use just ONE large filter. **The turbine case does not need to be taken apart to replace the filter.** To remove, simply turn the turbine on its side and pull the filter out. Wash in solvent and **dry** before replacing. All Fuji filters are a friction fit. When replacing, push the filter in by hand and finish up by using a screwdriver through the square holes to lever the filter into position. **The filter must fill the entire filter enclosure and always be FLUSH with the base of the turbine case.** The Mini-Mite Turbines use 2 filters, one fine and one coarse. Looking from the front of the turbine please insert the fine filter to the left side (near the 'F' of Fuji) and the coarse to the right side. It is important to keep the turbine as far away as possible from the spraying area (and workshop dust). If the filters become badly clogged, cooling air will be restricted - this may cause serious damage to the motor. **THE TURBINE MUST BE PLACED ON THE FLOOR - NOT UP HIGH. THIS IS BECAUSE THE BEND IN THE HOSE CAUSES BACK PRESSURE INTO THE MOTOR.**

For SERVICE & PARTS

USA

Fuji Spray

Phone: 800-650-0930 Online: www.hvlp.net

Phelps Refinishing

Phone: 800-377-5662 Online: www.phelpsrefinishing.net

UNITED KINGDOM

Axminster Power Tool Centre. Axminster, Devon, England

Phone: 01297 33656

Rutlands Limited. Bakewell, Derbyshire, England

Phone: 01629 815518

EUROPE

Larius SRL. (Lecco), Italy

Phone: 0341-621152

Aerometal. S.A. Spain/Portugal

Phone: 34-935620212

AUSTRALIA & NZ

apSM Tecni Pty Ltd. Campbellfield, Victoria 3061

Phone: 3-9359-5000

PUERTO RICO

Eagle Tools Mfg. Corp San Lorenzo, Puerto Rico, 00754

Phone: 787-736-0444

SOUTH KOREA

E-Woo Painting Technology. Seoul, Korea

Phone: 82-2-2103-1477 Fax: 82-2-2103-1488

Copyright © 2008 Fuji Industrial Spray Equipment Ltd. Toronto. Canada

GTX Gravity Gun (Accessory)

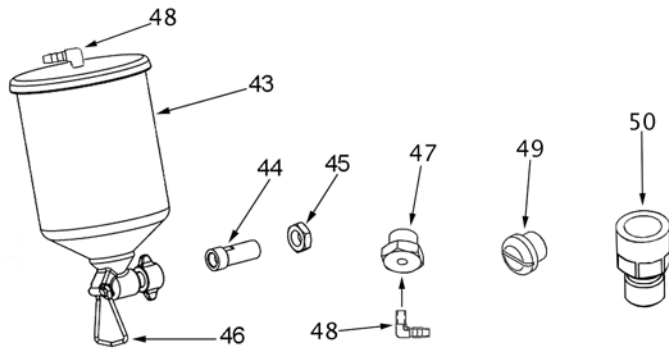

ITEM	PART	NAME	ITEM	PART	NUMBER
43	9850	Gravity Cup	47	2020	Nipple Adaptor
44	9051	Fluid Coupler	48	2021	Nipple
45	8067	Jamb Nut	49	8010	Air Plug
46	0000	Stand	50	8065	Hose Connector

The new GT-X Gravity Gun now offers the choice between pressurized or non-pressurized use – here's how...

PRESSURIZED CUP

The GTX spraygun is already setup to spray using the pressurized Gravity Cup. This is more suited to heavier paints such as Latex House Paint (Emulsion) and will also provide for faster coverage. But for a softer spray, you may want to try experimenting with a 'non-pressurized cup'.

Non-Pressurized Cup:

- 1) Remove the Pressure Tube from the 2021 Nipple on the Lid of the Cup
- 2) Unscrew the 2020 Nipple Adaptor (located under the front barrel of the gun).
- 3) Replace the 2020 Nipple Adaptor with the 8010 Air Plug (Supplied) to block the hole.

You can now spray with a non-pressurized Gravity Cup. This is more suited to thinner (less viscous) liquids. Coverage will be slower than with the pressurized cup.

AIR CONTROL VALVE

The air control valve 2032 is located on the hose next to the brass quick-connect. It provides you with a means of controlling the air flow through the gun. It offers you fingertip control when you need it to reduce bounceback and overspray. There is one thing to remember about the air control valve - it is the '**last in the chain**' of operations after...

- 1) Thinning the paint
- 2) Adjusting the shape and size of the spray pattern
- 3) Adjusting the flow of paint through the gun.

After performing these operations, you should spray a few passes onto a scrap piece of plywood or cardboard. This will allow you to determine if the paint (generic word for any type of coating) levels nicely. If there is 'orange-peel' then you must thin the product more. Once the gun is producing a perfect finish with full air, you may then experiment with turning the air down until bounceback is reduced to a minimum. However, if orange-peel results, you have no option but to turn the air up again a slight amount. With heavier paints (such as latex) spraying may be done with the valve fully open (or even removed). When excessive 'bounceback' or overspray is a problem, turn the lever to reduce the amount of air.

PLASTIC DIAPHRAGM - XT-2 MODEL

The XT 1 Quart pressurized cup (not found in the Gravity Spraygun) has a plastic diaphragm 2038. This diaphragm prevents paint from entering the pressure tube 2024. The small air hole in the diaphragm should not be placed directly below the air hole in the nipple. Position the diaphragm hole to the rear of the cup. The spraygun can be turned to different angles when spraying, however the cup should never be higher than the gun (above horizontal). To remove the diaphragm for cleaning, grab the small tab and slide it gently down the metal fluid tube. The diaphragm can be washed in thinner. **Note: There is no diaphragm on the Fuji GT-X Gravity Spraygun.**

GETTING STARTED

Your Fuji Spraygun has been adjusted at the factory and is ready for spraying. To clean out any impurities that may have accumulated during assembly or shipping, we recommend spraying a small quantity of clean paint thinner through the gun. Before tackling any serious spraying, experiment using plain water until you become familiar with all the controls.

HOSE CONNECTION

Connect the end of the hose (female connector) to the turbine air outlet. **ALWAYS TURN OFF THE TURBINE BEFORE DISCONNECTING THE GUN FROM THE HOSE.** This prevents unequal pressure in the cup forcing paint up the pressure tube.

CHANGING THE SHAPE OF THE FAN

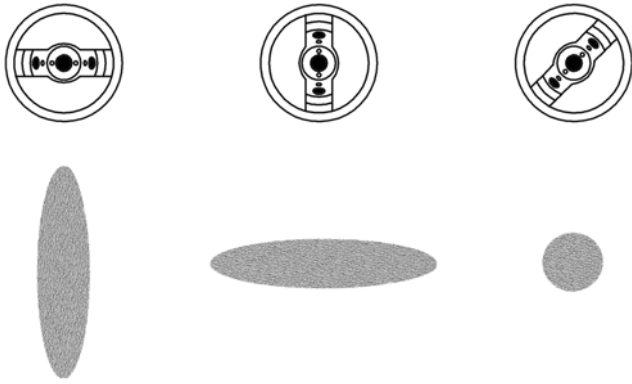

Turn the aircap 8002 until it clicks into the horizontal position. This setting produces a vertical fan useful for spraying from side to side. Then set the aircap in a vertical position. This setting produces a horizontal fan, useful for spraying up and down. Now try setting the aircap at a 45° angle. This setting produces a round fan pattern useful for spraying thinner objects. Remember to turn down the amount of paint when you switch to a smaller round fan, otherwise you will find that there will be too much paint concentrated in one spot. To test, try turning the fluid knob 8029 clockwise until you cannot pull the trigger. Then unscrew it a little until a small amount of paint material comes out of the nozzle when you depress the trigger. This results in a small circular fan. If you continue to depress the trigger and move along your workpiece you will get a fine line. From 6" away this will give you a fan about 1" - 2" in diameter. This would be handy for spraying thin spindles on a chair for instance. Then place the aircap to where it almost touches the test board and the fan size becomes extremely small - similar to an airbrush. Try writing your name with the gun. If you get runs then you will have to adjust the fluid knob again at the back of the gun. This type of technique is handy for repairs and touch-up. To obtain more coverage with a fuller spray, unscrew the fluid knob. Experimenting like this enables you to become familiar with your Fuji spraygun.

CHANGING THE FAN SIZE

If you are familiar with high pressure sprayguns, please read this section very carefully. The pattern size can be changed using **different** techniques.

One method used to adjust the size of the spray pattern is very different to what you are used to. The principal is simple... The aircap is backed by a spring and is 'floating'.

ITEM	PART	NAME
27	2023	Nipple
28	2024	Pressure Tube
29	9044	Paint Strainer
30	2041T	Teflon Cup
30	2041	Non-Teflon Cup
31	2037	Cup Gasket
32	2038	Diaphragm
33	7005	Gun Block
34	8007	Needle Packing (2)
35	8008	Packing Nut
36	8003	Seal - Fluid Coupler
37	8024	Spindle
38	8021	Spindle Valve
39	8027	Retainer Ring

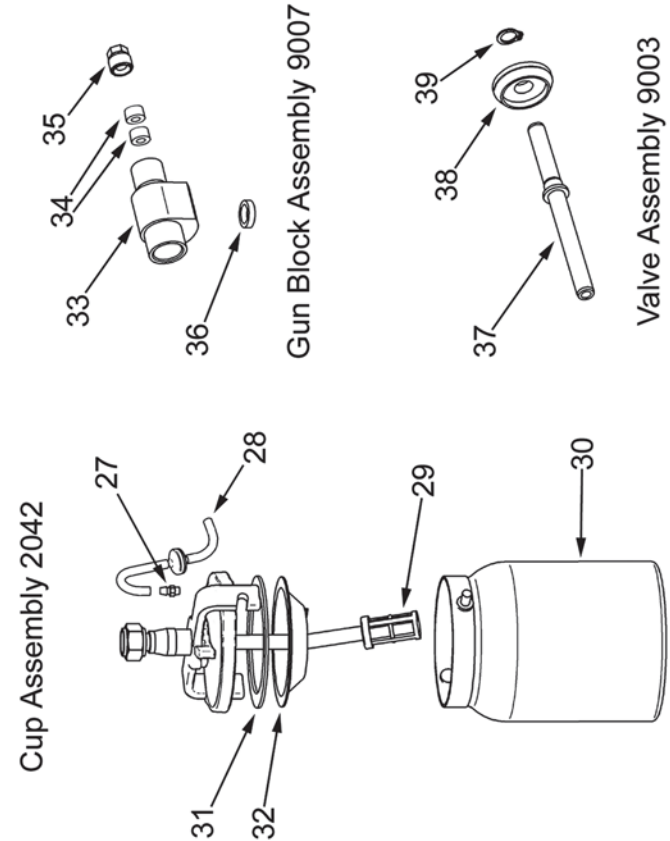

The Fuji XT-2 & GT-X2 Spraygun

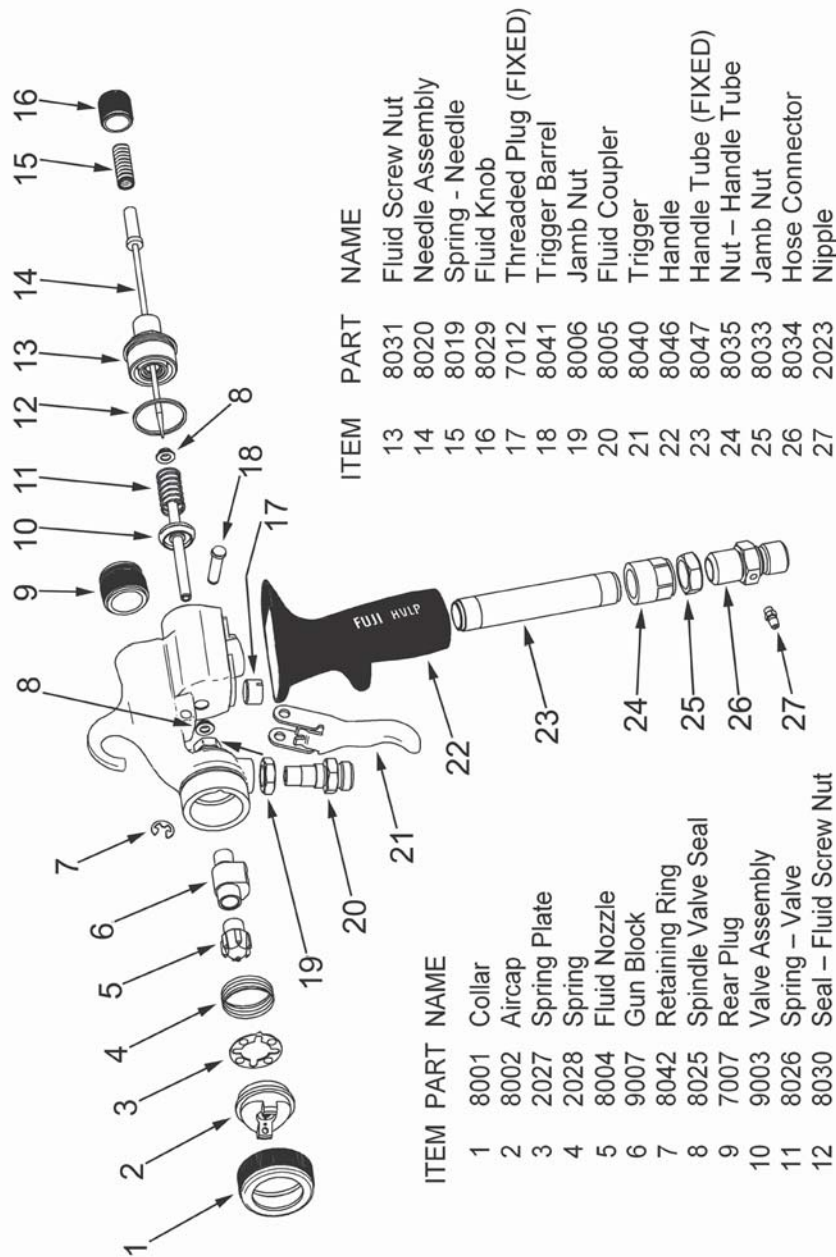

Please do not attempt to remove any part labeled 'FIXED'. They are permanently set in at the factory.

To change the **size** of the fan you will turn the collar 8001 clockwise or counter-clockwise. Winding the collar **IN** results in a **LARGER FAN**. Winding the collar **OUT** will result in a **SMALLER FAN**.

The standard position is shown in Fig A. The **tip of the fluid nozzle** should be **flush with the aircap**. Winding out the collar (counter-clockwise) causes more air to pass through the center hole and less to the horns. The result is a smaller fan. (Fig B). When the collar is screwed in, air is cut off from the center hole in the air cap. This redirects air to the horns resulting in a wider fan pattern. (Fig C). For Gravity Gun, please **see below**.

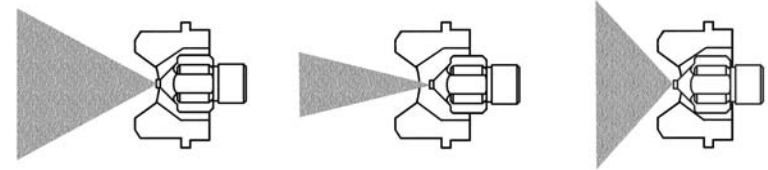

Fig. A

Fig. B

Fig. C

THE COLLAR 8001 SHOULD NEVER BE FULLY TIGHTENED - THIS WOULD CUT OFF THE AIR TO THE CENTER HOLE RESULTING IN A VERY ROUGH SPRAY PATTERN.

You can also regulate the fan size by changing the **distance** of the aircap to the surface being sprayed. The **closer the distance**, the **smaller the spray pattern size** and vice-versa.

Adjusting the fluid knob to reduce paint output will also reduce the fan size.

THE PRESSURE TUBE

When spraying, never hold the gun upside down. Keep the cup pointed downward below horizontal. The cup must always be lower than the gun.

Upon stopping spraying for any reason, first turn off the turbine. Disconnect the hose and then open the cup to release pressure. It's best to hang up the gun - use any type of hook, or rod for this.

Do not stand the gun on a bench or even the floor because it will always be prone to falling over which could damage the spraygun and cause paint to flow up the pressure tube and into the spraygun.

Any paint in the pressure tube 2024, or nipples 2023 the tube is attached to, causes reduced amounts of paint through the gun. This is because the cup pressure is too low. Air is being restricted through the nipples by the paint blockage. The symptom will be little or no paint and the reason will always be the nipples or pressure tube being clogged with dried paint.

ACTUAL SPRAYING TECHNIQUES.

The spraygun should be held perpendicular to the surface at all times. HOLD THE GUN NO MORE THAN 8" (20cm) AWAY FROM THE SURFACE TO BE PAINTED. But closer is ok.

CORRECT METHOD

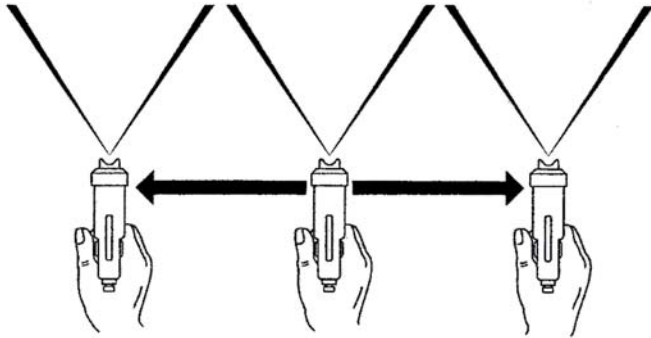

Start moving the spraygun in the direction you want to spray and press the trigger. Between each successive pass, overlap by about a quarter.

INCORRECT METHOD

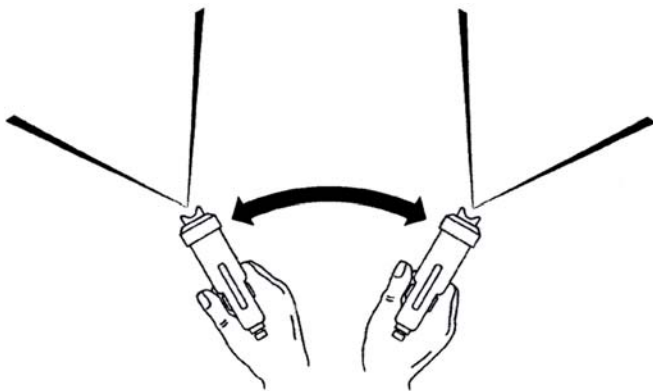

Never, for any reason, point the spraygun directly at the face, or head of a person.

INSTALLING THE SPRING PLATE

If the spring plate 2027 is installed upside down, the aircap will not click into position when turned. Also, when re-installing the spring plate, always ensure that the tab is positioned in the slot in the barrel.

SETTING DIRECTION OF NIPPLE ON HANDLE (XT-2 ONLY)

If for some reason you remove the hose connector 8034 you will have to re-set the direction of the nipple. The direction of the nipple at the air hose connector (base of handle) should be facing towards the nipple on the cup lid. To re-adjust, loosen jamb nut 8033, then turn the hose connector 8034 to the correct position and tighten jamb nut 8033. **The aluminum tube handle 8047 is NOT removable.**

CLEANING THE GUNBLOCK

As with all Fuji fluid components, this part is manufactured from stainless steel. To clean, flush solvent through the spraygun while the paint is still wet inside the gun. We do not recommend removing the gunblock unless it has been left for a prolonged period of time and is completely clogged up with dried paint. It is preferable to clean as stated below.

For a more thorough cleaning, remove all parts at the front of the barrel. (collar, aircap, spring plate, spring, fluid nozzle etc.)

Use the supplied cleaning brush 9045 wetted with solvent to remove paint particles. If necessary, dip the gun block portion of the gun into solvent to soak for a short period of time. **Please do not soak the whole gun in solvent**, this should never be necessary and it could damage the valve assembly and valve seals.

The cup assembly could also be removed by loosening the swivel nut at the top of the fluid tube.

TURBINE PROBLEMS

NO POWER - Check your power outlet. Also, try re-setting the breaker on the back of the turbine by pressing it once.

PLEASE DO NOT TRY TO SERVICE THE TURBINE YOURSELF. CONTACT US FOR TECHNICAL ASSISTANCE.

In an emergency, where you cannot have any 'down time' you could take the turbine unit to any Vacuum Repair Store. They are very familiar with the turbine motor and can check the electrical components very easily. The problem is most likely a loose electrical connection.

ADJUSTING THE NEEDLE PACKING

Like all spraygun manufacturers, we use 'stock' stainless steel rod for the needle. This rod can differ in diameter slightly with each production run. So if you change a No. 3 for a No. 4 needle, one could be a slightly oversized diameter and one slightly undersized. This may necessitate adjusting the needle packing.

The needle packing must be tight enough to prevent any leakage of paint material. It should however, allow the needle to glide smoothly through it. If the packing is too loose, you will see a small amount of paint where the needle passes through the small needle packing nut 8008. Using the supplied wrench, gently tighten the nut. This is a good time to apply a spot of oil to the needle where it passes through the packing nut.

The needle packing 8007 is made from long-lasting teflon and should never need replacing. But, if necessary, it can be replaced by removing the needle 8020, then the needle packing nut 8008. Using a sharp tool, pry out the needle packing. Be careful not to damage any threads. Drop in the replacement needle packing and re-assemble.

THE SPINDLE VALVE ASSEMBLY

The spindle valve assembly 9003 can be removed as follows.

- 1) Remove the fluid knob 8029, spring 8019, and gently pull out the needle assembly 8020.
- 2) Turn out the fluid screw nut 8031 (a socket is preferable to a wrench).
- 3) Remove the spring 8026 and gently pull out the spindle valve assembly 9003.

To replace, reverse the procedure being careful to center the spring 8026 onto the spindle valve 8021. Also, before tightening in the fluid screw nut please ensure that the spindle is centered in the seal. The end of the spindle is visible through the hole in the fluid screw nut.

THE SPINDLE VALVE SEALS

Removal and replacement of the spindle valve seals is simple. Any thin, flat tool such as a screwdriver can gently pry out the seal. To replace, firmly push the seal into place. Small leaks of air are not important and will have absolutely no effect whatsoever on the atomization process.

The seals are designed to be durable and long-lasting under normal working conditions. We do not recommend the practice of dunking the whole spraygun into a container of solvent. This may damage the valve and valve seals.

AIRCAP SET SELECTION

The fluid nozzle 8004 and needle 8020 MUST always match exactly. Size No.4 is standard with all Fuji sprayguns. No. 3 or No. 4 can be used for any type of fine-finishing application. The difference between the two is that the #4 allows for more fluid output. This is desirable when spraying fast drying lacquers. It allows you to spray faster and wetter to obtain better leveling of the finish. 3 additional setups are available as accessories. Generally speaking, the quality of atomization and finish suffers as you go to the larger size setups (No.5 and 6).

AIRCAP SET - Part 9001



If you do not intend on spraying walls & ceilings then the only two setups you would ever need would be the #3 Fine and Standard #4.

No. 3 (Part 9001-3) 1mm (.039") FINE OUTPUT

WATER-BASED LACQUERS, NITROCELLULOSE LACQUER, SEALERS, CELLULOSE, ACRYLICS, SYNTHETICS, POLYURETHANE, STAINS.

No. 4 (Part 9001-4) 1.4mm (.055") MEDIUM OUTPUT - STANDARD

Similar to No. 3 but more coverage. Best for AUTOMOTIVE ENAMELS, NITROCELLULOSE LACQUER and LATEX where finer finish is required such as louver doors, trim, cabinets (see section about Latex). Also ideal for VARNISHES, PRIMERS, OIL-BASED PAINTS and STAINS.

No. 5 (Part 9001-5) 1.8mm (.070") HIGH OUTPUT

Larger surfaces, thick layers, spotted effects. SEALERS, VARNISH, POLYURETHANE, OIL BASE PAINTS, ENAMELS, EPOXY, PLASTIC, ADHESIVES, FLOOR PAVING PAINTS, LATEX, ETC.

No. 6 (Part 9001-6) 2.2mm (.086") EXTRA HIGH OUTPUT

Very heavy flows, fast coverage. STONE FINISH PAINTS, TEXTURE COATING, INDUSTRIAL PRIMERS, MULTI-FLECK PAINTS, LATEX (on walls, ceilings) ETC.

A WORD ABOUT LATEX (EMULSION) PAINT

Although latex house paint was never originally intended to be sprayed, a professional finish can be achieved by following a few simple rules. (Please do not confuse latex with the newer water-based coatings). For work such as cabinetry or trim, our equipment can be used successfully with latex paint. The latex will have to be thinned with **WATER** - approximately **20-30% depending on the brand of paint**. And to improve the finish even more, you can use an additive that will slow down the drying process so that the paint levels out nicely. One product available is FLOETROL from the FLOOD Company in Ohio. In the USA Call 1-800-321-3444 for your nearest supplier. (In the U.K. 0845-0618899).

The ideal Aircap size setup is the #4 for household trim, louver doors etc. The Latex paint should be 'finish-quality' and not a cheaper grade.

When spraying Latex, please adjust the fluid knob to limit the paint to a finer spray. This will increase the ratio of air to paint and result in better atomization and a beautiful finish. (Factually speaking, it doesn't increase the ratio of air to paint but does the opposite - it allows the air atomizing power to work on less paint thereby improving the quality of atomization). Also, it is usually helpful to remove the air control valve so that more air passes through the spraygun. Finally, adjust the pattern to a maximum size of 8" - 9" (20cm) - smaller is ok.

Although it is possible to use our equipment for house painting (walls), and many end users do, we feel that an airless gun or power roller is better suited to that kind of job. However, if you decide to do this kind of work, you will need the #6 Aircap set.

VISCOSITY

Follow the viscosity guide chart. You will eventually learn to thin the material by experience. Traditionally, lacquers were thinned 50/50 even for high pressure spraying but this much thinning is not necessary. However, coatings manufacturers are reformulating constantly so it is always advisable to check with them. Thinning a product excessively causes more overspray as well as runs. Stringent air quality controls in some geographic locations may prohibit reducing by more than a certain percentage. Please check with the local jurisdiction in this matter.

Remember, when you buy a can of paint, lacquer, polyurethane, varnish etc. over the counter, it will most likely be formulated for brushing. That means, it will be too viscous (thick) and will require thinning to spray successfully. This is especially true if there is no mention of spraying on the instructions on the can. Check with the manufacturer of the coating to obtain advice on thinning their product.

THE TRIGGER IS SLUGGISH

- The needle packing is too tight - see ADJUSTING THE NEEDLE PACKING. Page 14
- Bent needle
- The valve seal 8025 is damaged - replace

POOR SPRAY PATTERN

- Damaged needle or nozzle
- Nozzle is clogged
- Air holes in air cap clogged
- Aircap screwed in too tight
- Gun too far from surface (max. 8" - 20cm)

PAINT AT THE AIR NOZZLE HOLES

- The fluid nozzle is loose and material is leaking around it - tighten with the wrench (supplied)
- Paint is entering the gun via the pressure tube (very rare) and being blown through the barrel to the aircap - see HOW TO PREVENT PAINT ENTERING THE PRESSURE TUBE. Page 4

GUN SPRAYS IN A PULSATING MANNER

- The needle packing has worn a little or is loose. Tighten
- The cup is almost empty
- The cup lid is not tight - air is escaping
- The 2024 clear plastic pressure tube is leaking air. Replace
- The pressure tube and/or nipple is clogged. Clear or replace

EXCESSIVE OVERSPRAY

- The collar 8001 is screwed in too tight
- The spray pattern size is too large for the item you are spraying
- The gun is being held too far away - should be 8" max. (20cm)
- Trigger on and off as you pass over the edges of the item
- The product is too thin - try thinning less
- Reduce the air by turning the air control valve to the point where overspray is minimized but the finish still looks good
- For ideal and comfortable spraying conditions, you should install an extraction fan.* If you are spraying a flammable, combustible product such as nitrocellulose lacquer, you must install an explosion-proof fan (and explosion-proof lighting and switches)

* Please check with the local jurisdiction on this matter.

SPRAYGUN PROBLEMS

NO PAINT (OR VERY LITTLE PAINT)

THIS IS THE MOST COMMON PROBLEM ENCOUNTERED -

The air passing through the plastic tube 2024 to pressurize the cup is blocked. This means that either the tube itself, the check valve, or one of the two nipples 2023 is blocked. A pipe cleaner can be used for cleaning the hole in the nipple. Please see more info on the pressure tube' - **Page 5**

- Pressurizing tube and/or nipples are blocked (XT-2 Gun)
- The cup is not tightened down sufficiently by the quick-release lever or the cup gasket 2037 is worn and leaking air
- The cup is empty
- The metal fluid tube is blocked with paint - very rare (XT-2 Gun)

UNEVEN SPRAY PATTERN

One of the holes in the aircap may be blocked. Or, the paint could be dirty and is partially blocking the fluid nozzle. Remove the aircap and clean by soaking in solvent and using the soft bristle brush or a rag. NEVER use metal objects to clean holes in the aircap.

LEAKAGE

If paint material comes out of the fluid nozzle **without** pulling the trigger...

- The needle is not seating in the fluid nozzle properly
- The needle packing may be too tight preventing the needle from moving
- Foreign matter could be trapped between the needle and fluid nozzle
- The needle or fluid nozzle could be damaged or worn
- Loose fluid nozzle
- Wrong nozzle size installed

CUP LEAKS

- Oil above and below the lever to smooth the lever action
- Change gasket/diaphragm - oil lever first to check (XT-2 Gun)
- Leak around nipple - use Loctite to seal
- Leak around side pins - use Loctite to seal
- Leak through lid - remove nut under lid - use Loctite (XT-2 Gun)

VISCOSITY GUIDE

To test the viscosity of the paint material, fill the viscosity cup to the brim and time how long it takes for the liquid to empty out through the hole. We recommend you experiment to find the ideal viscosity for your application and record the information for the next time.

Always check with the manufacturer of the coating for assistance in thinning for spraying. If their product is only designed to be brushed, they may not be too helpful. But remember that any type of coating can be sprayed if it is thinned correctly and you have installed the ideal aircap set.

The chart below is only an approximate guide denoting how many SECONDS it takes for thinned material to flow through the viscosity cup.

Auto Cellulose	18 - 20	Primers	30 - 40
Lacquers	18 - 20	Sanding Sealers	20 - 22
Enamels	20 - 25	Stains	Undiluted
Latex	20 - 30	Creosote	Undiluted
Oil-based	20 - 25	Polyurethanes	20 - 25

We suggest around thinning 25% to begin with but this may contravene the air quality control laws for your location. The solvent used for thinning is usually the solvent mentioned on the can (instructions for 'cleaning the brushes'). However, please check with the coatings manufacturer.

HVLP spraying is more friendly to the environment than most methods of spraying. It reduces appreciably the amount of unnecessary misting and fogging (overspray) associated with high-pressure spraying. Spraying with Nitrocellulose lacquer can be **hazardous. The lacquer, fumes and overspray are toxic, flammable and explosive.** If spraying must be done inside an enclosed area, **ventilate well.** Spray close to an open window or door and situate a fan to draw out the fumes (an explosion-proof motor and explosion proof lighting will be necessary). PLEASE CHECK WITH THE LOCAL AUTHORITY HAVING JURISDICTION ON THIS MATTER.

CLEANING

To clean the gun after each use, empty all paint from the cup. Use a solvent soaked rag to clean the residue in the cup. Then, spray some clean solvent through the gun into a clean rag (to avoid filling the room with unnecessary spray) or a bucket. Repeat until the inside of the gunblock 7005, metal fluid tube etc. is clean. Use the wet rag to wipe off the aircap and tip of the fluid nozzle.

Back-flushing is not necessary. Do not restrict the fluid nozzle when cleaning - this will drive thinned paint up the pressure tube and into the spraygun which is undesirable.

If this type of cleaning is done while the paint is still wet in the gun, it should be all that is necessary to keep the gun clean enough for next time. Do not leave liquids in the cup overnight or for long periods. **The Gravity Gun can be cleaned without hooking up to the hose. Simply wind out the fluid knob all the way and pull the trigger - the thinner (solvent) will stream out of the fluid nozzle. Repeat until clean.**

PLEASE DO NOT USE A WIRE BRUSH OR ANYTHING METAL TO CLEAN THE GUN OR CUP AS THIS WILL CAUSE DAMAGE.

DO NOT disassemble the cup assembly - threads in your cup have been sealed at the factory to prevent leakage under pressure.

The standard 1 quart (1000cc) cup can be used with most coatings (including water-based). Also available as an accessory is our 2041T teflon-coated cup. The 2041T can be used for water-based products.

CAUTION: Never soak the complete spraygun in solvent as this removes the grease from the parts and distributes thinned paints throughout the air passages. It could also damage internal parts such as the spindle valve 8021 or valve seals 8025. It may however, be necessary sometimes to soak the front barrel in thinner. Please remove nylon parts before soaking. **You may soak only the metal parts in solvent and clean with the soft bristle cleaning brush 9045.** To reassemble, first oil or grease all moving and threaded parts.

CAUTION: Do not store the gun with the cup clamped down hard as this will cause the gasket to flatten out. Do not lay the gun down on its side with liquid material in it.

PRESSURE POT USE

To use the gun with a pressure pot, remove the cup assembly 2042 and the pressurizing tube 2024. Connect your material line (fluid hose) to the fluid coupler 8005 on the gun. Because you are using air from the turbine, you must block off the air that would normally go from the pressure pot to the gun. This can be capped with a brass threaded cap or the coupler can be removed and a threaded brass plug inserted. Also, a cap must be placed over the nipple to prevent air escaping - this plastic cap - Part 2023B is available from Fuji. Then attach the turbine hose to the hose connector 8034 in the regular way.

A COMPRESSOR IS NEEDED TO PRESSURIZE THE POT.

Set the compressor to between 6-8 PSI. This is enough to push the paint material up to the gun. For spraying at greater heights (over 8 feet), more fluid pressure may be necessary. The fluid pressure should never be set at more than 20 PSI. If you find a higher pressure is needed, we advise you to check the material hose for paint blockage.

FINISH PROBLEMS

ORANGE PEEL - If the finish is rough and resembles orange peel then the material is too thick. (Or perhaps you have the air control valve turned down - please check that it is fully open). The 'paint' will not atomize properly and the surface will be spotty. To remedy this, add more thinner (or appropriate solvent). For fast drying products such as lacquers, you may also want to add a lacquer retarder. This will slow the drying time allowing the material to flow out and level nicely.

Retarders are available for other coatings too, such as Penetrol for oil-based paints or Floetrol for latex house paints. These products go under different names such as Flow-Out Additives etc. Please check with the coatings manufacturer.

NOTE: With the newer water-based materials 'orange peel' is usually a result of spraying on too thick a film. **Try spraying an extremely THIN FILM, but still WET coat.** With most other coatings, orange peel is caused by material being too thick or not enough atomizing power. This is why we suggest leaving the air control valve fully open when experimenting with a new coating material, otherwise it will cause confusion. If the the air control valve is fully open (or perhaps removed for Latex spraying) then orange peel can only be one cause - the material is too thick and must be thinned.

GRITTY FINISH - If the material is too thin, it is likely to run or be over-atomized, producing a rough gritty finish. Try thinning the product less and spraying a wetter coat.

BLUSHING - Blushing is the common term used when the finish looks cloudy and white (sometimes also called blooming). It is caused by moisture and is especially a problem when operating high pressure spray equipment. The moisture comes from the compressor. This problem does not usually occur when using the Fuji turbine because the air from the turbine is warm, dry and uncontaminated. However, it is possible on very humid days to encounter slight blushing. Using a retarder will often allow moisture to escape, preventing the milky look.

FISH EYES - If you are refinishing furniture or pianos, fish eyes could become a problem. The cause is usually silicone or oil from polish which has been liquified by the paint stripper that has now soaked into the bare wood. This silicone prevents the lacquer from adhering to the wood. One way to sometimes correct this is to seal in the silicone by misting on two or three light coats of lacquer. Then spray on a regular wet coat. We *do not* recommend the use of a product known as 'Fish-Eye Drops' which is essentially liquid silicone. Silicone will only contaminate the gun even further. Anything that comes into contact with the silicone becomes contaminated - such as; rags, aprons, bench tops, gloves.